

**Major Ratings and Characteristics**

Characteristics	90SQ...	Units
$I_{F(AV)}$ Rectangular waveform	9	A
$V_{RRM}$ range	30/ 45	V
$I_{FSM}$ @tp = 5 $\mu$ s sine	2150	A
$V_F$ @9 Apk, $T_J = 125^\circ\text{C}$	0.42	V
$T_J$ range	-55 to 150	$^\circ\text{C}$

**Description/ Features**

The 90SQ axial leaded Schottky rectifier series has been optimized for very low forward voltage drop, with moderate leakage. The proprietary barrier technology allows for reliable operation up to 150°C junction temperature. Typical applications are in switching power supplies, converters, free-wheeling diodes, and reverse battery protection.

- 150° C  $T_J$  operation
- High purity, high temperature epoxy encapsulation for enhanced mechanical strength and moisture resistance
- Very low forward voltage drop
- High frequency operation
- Guard ring for enhanced ruggedness and long term reliability
- Lead-Free plating

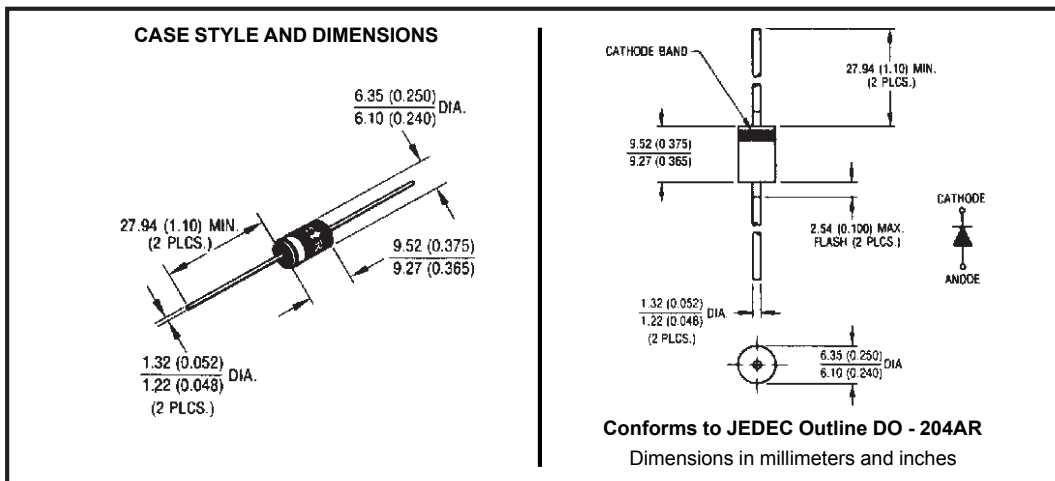

## Voltage Ratings

Part number	90SQ030	90SQ035	90SQ040	90SQ045
$V_R$ Max. DC Reverse Voltage (V)	30	35	40	45
$V_{RWM}$ Max. Working Peak Reverse Voltage (V)				

## Absolute Maximum Ratings

Parameters	90SQ	Units	Conditions
$I_{F(AV)}$ Max. Average Forward Current * See Fig. 5	9	A	50% duty cycle @ $T_C = 69^\circ\text{C}$ , rectangular wave form
$I_{FSM}$ Max. Peak One Cycle Non-Repetitive Surge Current * See Fig. 7	2150	A	Following any rated load condition and with rated $V_{RWM}$ applied
	340		
$E_{AS}$ Non-Repetitive Avalanche Energy	12	mJ	$T_J = 25^\circ\text{C}$ , $I_{AS} = 1.8$ Amps, $L = 7.4$ mH
$I_{AR}$ Repetitive Avalanche Current	1.8	A	Current decaying linearly to zero in 1 $\mu\text{sec}$ Frequency limited by $T_J$ max. $V_A = 1.5 \times V_R$ typical

## Electrical Specifications

Parameters	90SQ	Units	Conditions
$V_{FM}$ Max. Forward Voltage Drop (1) * See Fig. 1	0.48	V	@ 9A
	0.57	V	@ 18A
	0.42	V	@ 9A
	0.52	V	@ 18A
$I_{RM}$ Max. Reverse Leakage Current (1) * See Fig. 2	1.75	mA	$T_J = 25^\circ\text{C}$
	70	mA	$T_J = 125^\circ\text{C}$
$C_T$ Max. Junction Capacitance	900	pF	$V_R = 5V_{DC}$ , (test signal range 100Khz to 1Mhz) $25^\circ\text{C}$
$L_S$ Typical Series Inductance	10.0	nH	Measured lead to lead 5mm from body
$dv/dt$ Max. Voltage Rate of Change (Rated $V_R$ )	10000	V/ $\mu\text{s}$	

(1) Pulse Width < 300 $\mu\text{s}$ , Duty Cycle < 2%

## Thermal-Mechanical Specifications

Parameters	90SQ	Units	Conditions
$T_J$ Max. Junction Temperature Range	-55 to 150	$^\circ\text{C}$	
$T_{stg}$ Max. Storage Temperature Range	-55 to 150	$^\circ\text{C}$	
$R_{thJL}$ Max. Thermal Resistance Junction to Lead	8.0	$^\circ\text{C}/\text{W}$	DC operation * See Fig. 4 1/8 inch lead length
$R_{thJA}$ Typical Thermal Resistance, Junction to Air	44	$^\circ\text{C}/\text{W}$	
wt Approximate Weight	1.4(0.049)	g(oz.)	
Case Style	DO-204AR	JEDEC	

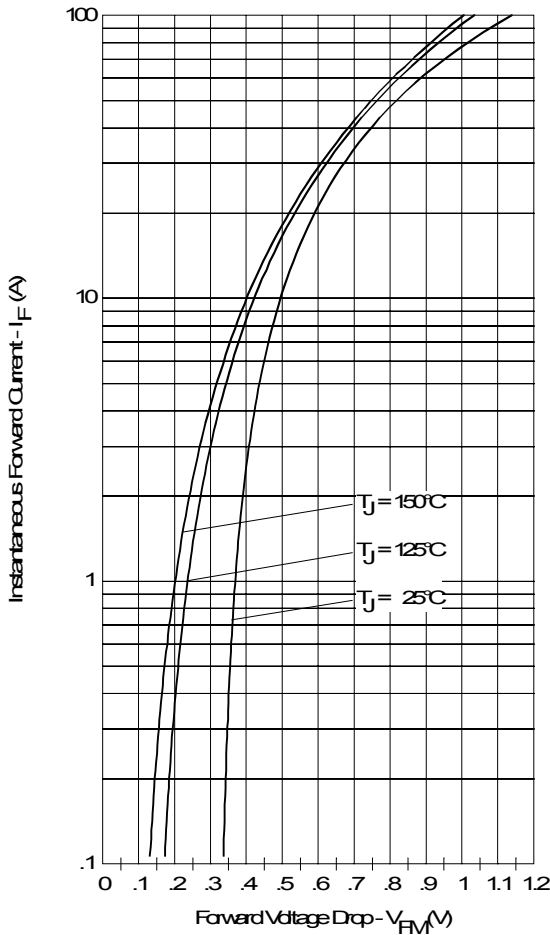

Fig. 1 - Maximum Forward Voltage Drop Characteristics

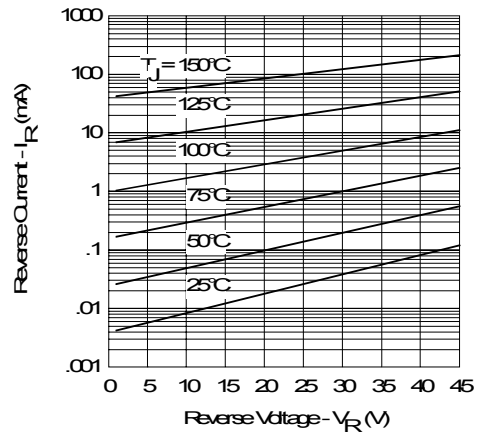

Fig. 2 - Typical Values of Reverse Current Vs. Reverse Voltage

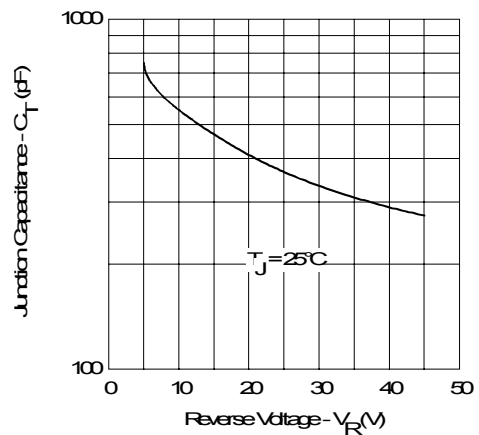

Fig. 3 - Typical Junction Capacitance Vs. Reverse Voltage

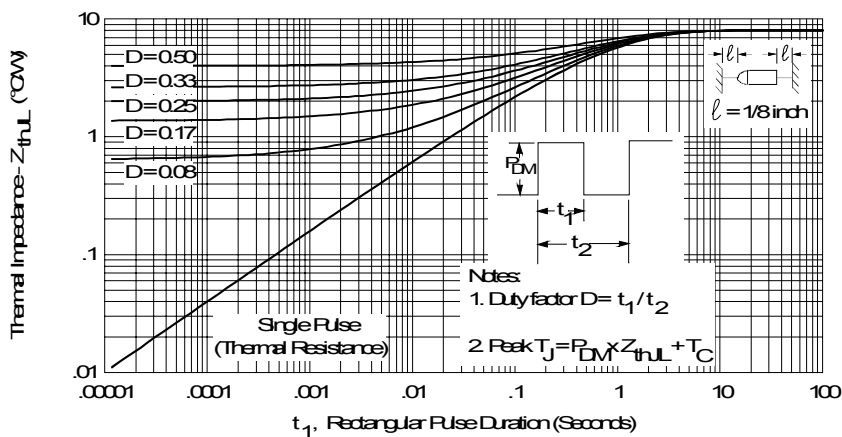

Fig. 4 - Maximum Thermal Impedance  $Z_{thJL}$  Characteristics

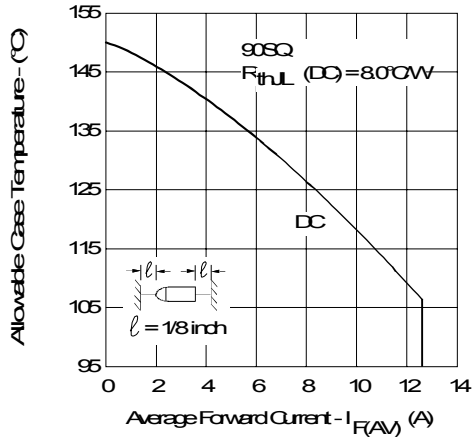

Fig. 5 - Maximum Allowable Case Temperature Vs. Average Forward Current

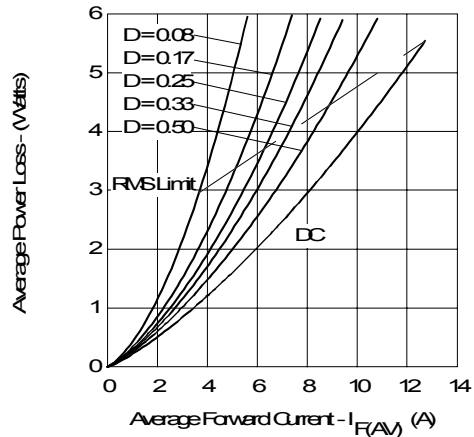

Fig. 6 - Forward Power Loss Characteristics

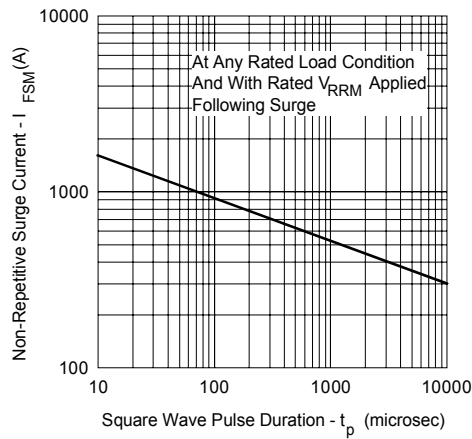

Fig. 7 - Maximum Non-Repetitive Surge Current

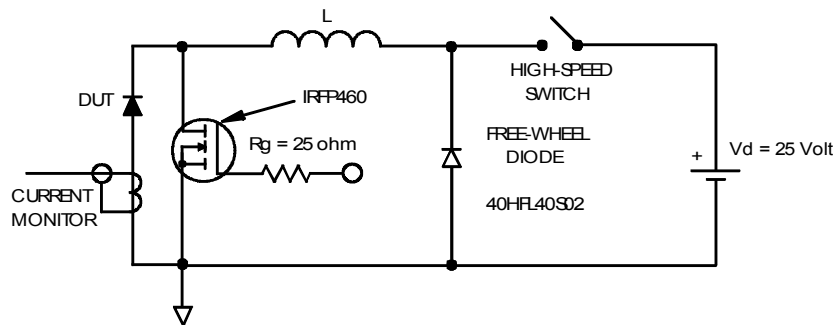

Fig. 8 - Unclamped Inductive Test Circuit

Ordering Information Table

Device Code											
	<table border="1" style="margin: auto;"> <tr> <td style="padding: 5px;">90</td> <td style="padding: 5px;">S</td> <td style="padding: 5px;">Q</td> <td style="padding: 5px;">045</td> <td style="padding: 5px;">TR</td> </tr> <tr> <td style="text-align: center;">①</td> <td style="text-align: center;">②</td> <td style="text-align: center;">③</td> <td style="text-align: center;">④</td> <td style="text-align: center;">⑤</td> </tr> </table>	90	S	Q	045	TR	①	②	③	④	⑤
90	S	Q	045	TR							
①	②	③	④	⑤							
<b>1</b>	- 90 = current x 10										
<b>2</b>	- S = DO-204AR										
<b>3</b>	- Q = Schottky Q Series										
<b>4</b>	- Voltage Rating										
<b>5</b>	- TR = Tape & Reel package (1500 pcs) - = Box package (200 pcs)										
	030 = 30V 035 = 35V 040 = 40V 045 = 45V										

Data and specifications subject to change without notice.  
 This product has been designed and qualified for Industrial Level and Lead-Free.  
 Qualification Standards can be found on IR's Web site.



## Notice

The products described herein were acquired by Vishay Intertechnology, Inc., as part of its acquisition of International Rectifier's Power Control Systems (PCS) business, which closed in April 2007. Specifications of the products displayed herein are pending review by Vishay and are subject to the terms and conditions shown below.

Specifications of the products displayed herein are subject to change without notice. Vishay Intertechnology, Inc., or anyone on its behalf, assumes no responsibility or liability for any errors or inaccuracies.

Information contained herein is intended to provide a product description only. No license, express or implied, by estoppel or otherwise, to any intellectual property rights is granted by this document. Except as provided in Vishay's terms and conditions of sale for such products, Vishay assumes no liability whatsoever, and disclaims any express or implied warranty, relating to sale and/or use of Vishay products including liability or warranties relating to fitness for a particular purpose, merchantability, or infringement of any patent, copyright, or other intellectual property right.

The products shown herein are not designed for use in medical, life-saving, or life-sustaining applications. Customers using or selling these products for use in such applications do so at their own risk and agree to fully indemnify Vishay for any damages resulting from such improper use or sale.

International Rectifier®, IR®, the IR logo, HEXFET®, HEXSense®, HEXDIP®, DOL®, INTERO®, and POWIRTRAIN® are registered trademarks of International Rectifier Corporation in the U.S. and other countries. All other product names noted herein may be trademarks of their respective owners.